

---

**MIGHTY** Mighty5  
Mighty5 Sub

**USER MANUAL**

---



# GENERAL INFORMATION

Thank you very much for your choice of loudspeaker product for your application!

In order to feel assured that you have gained a good grasp of every feature provided by your new unit, owner's manual should be read in its entirety.

The manual should be saved and kept on hand as a convenient reference.

## Introduction





- 1: This product utilizes line-array design which can be used for long-distance sound reinforcement.
- 2: This product has a variety of configurations to adapt to different occasions of use.
- 3: The satellite can be adjusted with independent pitching angle, so that you can obtain the ideal sound field coverage of the whole system.
- 4: This product features with simple and fast disassembly design which can save you installation time.

## Contents











<b>GENERAL INFORMATION</b> .....	<b>3</b>
<b>SAFETY GUIDELINES</b> .....	<b>4</b>
<b>PRODUCT ANNOUNCEMENT</b> .....	<b>7</b>
<b>ACCESSORIES</b> .....	<b>8</b>
<b>CONFIGURATION</b> .....	<b>9</b>
<b>INSTALLATION&amp;CONNECTION</b> .....	<b>12</b>
<b>FUNCTION INSTRUCTION</b> .....	<b>16</b>
<b>FUNCTION INSTRUCTION</b> .....	<b>18</b>
<b>SPECIFICATION</b> .....	<b>20</b>
<b>SUPPORT AND TROUBLESHOOTING</b> .....	<b>21</b>

# SAFETY GUIDELINES

## INSTRUCTIONS FOR THE PREVENTION OF FIRE, ELECTRIC SHOCK, OR INJURY TO PERSONS

















About WARNING and CAUTION Notices		About the Symbols	
 <b>WARNING</b>	Used for instructions intended to alert the user to the risk of death or severe injury should the unit be used improperly.		This symbol alerts the user to important instructions or warnings.
 <b>CAUTION</b>	Used for instructions intended to alert the user to the risk of injury or material damage should the unit be used improperly.		This symbol alerts the user to items that must never be carried out (are forbidden).

### ALWAYS OBSERVE THE FOLLOWING

WARNING		WARNING	
	Before using this unit, make sure to read the instructions below, and the Owner's Manual.		Use only the attached power-supply cord. Also, the supplied power cord must not be used with any other device.
	Do not open (or modify in any way) the unit or its AC adaptor.		Do not excessively twist or bend the power cord, nor place heavy objects on it. Doing so can damage the cord, producing severed elements and short circuits. Damaged cords are fire and shock hazards.
	Do not attempt to repair the unit, or replace parts within it(except when this manual provides specific instructions directing you to do so). Refer all servicing to your retailer or the nearest authorized Service Center.		This unit, either alone or in combination with an amplifier and headphones or speakers, may be capable of producing sound levels that could cause permanent hearing loss. Do not operate for a long period of time at a high volume level, or at a level that is uncomfortable. If you experience any hearing loss or ringing in the ears, you should immediately stop using the unit, and consult an audiologist.
	Never use or store the unit in places that are: <ul style="list-style-type: none"> <li>●Subject to temperature extremes(e.g., direct sunlight in an enclosed vehicle, near a heating duct, on top of heat-generating equipment); or are</li> <li>●Damp and humid(e.g., baths, washrooms, on wet floors); or are</li> <li>●Exposed to rain; or are</li> <li>●Dusty; or are</li> <li>●Subject to high levels of vibration.</li> </ul>		Do not allow any objects (e.g., flammable material, coins, pins); or liquids of any kind (water, soft drinks, etc.) to penetrate the unit.
	Make sure you always have the unit placed so it is level and sure to remain stable. Never place it on stands that could wobble, or on inclined surfaces.		Immediately turn the power off, remove the AC adaptor from the outlet, and request servicing by your retailer or the nearest authorized Service Center when: The AC adaptor, the power-supply cord, or the plug has been damaged; or If smoke or unusual odor occurs Objects have fallen into, or liquid has been spilled onto the unit; or The unit has been exposed to rain (or otherwise has become wet); or The unit does not appear to operate normally or exhibits a marked change in performance.
	Be sure to use only the AC adaptor supplied with the unit. Also, make sure the line voltage at the installation matches the input voltage specified on the AC adaptor's body.		

# SAFETY GUIDELINES

ALWAYS OBSERVE THE FOLLOWING

WARNING		CAUTION	
	Protect the unit from strong impact. (Do not drop it!)		Try to prevent cords and cables from becoming entangled. Also, all cords and cables should be placed so they are out of the reach of children.
	Do not force the unit's power-supply cord to share an outlet with an unreasonable number of other devices. Be especially careful when using extension cords-the total power used by all devices you have connected to the extension cord's outlet must never exceed the power rating (watts/amperes) for the extension cord. Excessive loads can cause the insulation on the cord to heat up and eventually melt through.		Never climb on top of, nor place heavy objects on the unit.
	Before using the unit in a foreign country, consult with your retailer or the nearest authorized Service Center.		Never handle the AC adaptor or its plugs with wet hands when plugging into, or unplugging from, an outlet or this unit.
	Batteries must never be recharged, heated, taken apart, or thrown into fire or water.		Before moving the unit, disconnect the AC adaptor and all cords coming from external devices.
	Only switching off the unit and unplugging from an outlet, the unit is powered off completely.		Before cleaning the unit, turn off the power and unplug the AC adaptor from the outlet.
	The unit and the AC adaptor should be located so their location or position does not interfere with their proper ventilation.		Whenever you suspect the possibility of lightning in your area, disconnect the AC adaptor from the outlet.
	Always grasp only the plug on the AC adaptor cord when plugging into, or unplugging from, an outlet or this unit.		<p>If used improperly, batteries may explode or leak and cause damage or injury. In the interest of safety, please read and observe the following precautions.</p> <ul style="list-style-type: none"> <li>● Carefully follow the installation instructions for batteries, and make sure you observe the correct polarity.</li> <li>● Avoid using new batteries together with used ones.</li> <li>● If a battery has leaked, use a soft piece of cloth or paper towel to wipe all remnants of the discharge from the battery compartment. Then install new batteries. To avoid inflammation of the skin, make sure that none of the battery discharge gets onto your hands or skin. Exercise the utmost caution so that none of the discharge gets near your eyes. Immediately rinse the affected area with running water if any of the discharge has entered the eyes.</li> <li>● Never keep batteries together with metallic objects such as ballpoint pens, necklaces, hairpins, etc.</li> <li>● Dispose of the waste battery according to national or local regulations regarding hazardous waste.</li> </ul>
	At regular intervals, you should unplug the AC adaptor and clean it by using a dry cloth to wipe all dust and other accumulations away from its prongs. Also, disconnect the power plug from the power outlet whenever the unit is to remain unused for an extended period of time. Any accumulation of dust between the power plug and the power outlet can result in poor insulation and lead to fire.		Should you remove screws, keep them in a safe place out of children's reach, so there is no chance of them being swallowed accidentally.
			Shock hazardous voltages and currents are present inside the enclosure. Do not remove and replace the speaker grill and speaker by any means.

# SAFETY GUIDELINES

ALWAYS OBSERVE THE FOLLOWING

## IMPORTANT NOTES

### Power Supply: Use of Batteries

- Do not connect this unit to same electrical outlet that is being used by an electrical appliance that is controlled by an inverter (such as a refrigerator, washing machine, microwave oven, or air conditioner), or that contains a motor. Depending on the way in which the electrical appliance is used, power supply noise may cause this unit to malfunction or may produce audible noise. If it is not practical to use a separate electrical outlet, connect a power supply noise filter between this unit and the electrical outlet.
- The AC adaptor will begin to generate heat after long hours of consecutive use. This is normal, and is not a cause for concern.
- When installing or replacing batteries, always turn off the power on this unit and disconnect any other devices you may have connected. This way, you can prevent malfunction and /or damage to speakers or other devices.
- Use only suitable rechargeable batteries of the same size and type. Make sure the polarity is correct. Or it may cause this unit to malfunction.
- Please charge the battery as soon as you can when in low energy. The battery's storage capacity goes down if not using it for a long time.

Note: Please charge the battery once a month regularly if not using it for long period.

### Placement

- Using the unit near power amplifier (or other equipment containing large power transformers) may induce hum. To alleviate the problem, change the orientation of this unit; or move it farther away from the source of interference.
- This device may interfere with radio and television reception. Do not use this device in the vicinity of such receivers.
- Noise may be produced if wireless communications devices, such as cell phones, are operated in the vicinity of this unit. Such noise could occur when receiving or initiating a call, or while conversing. Should you experience such problems, you should relocate such wireless devices so they are at a greater distance from this unit, or switch them off.
- Do not expose the unit to direct sunlight, place it near devices that radiate heat, leave it inside an enclosed vehicle, or otherwise subject it to temperature extremes. Also, do not allow lighting devices that normally are used while their light source is very close to the unit (such as a piano light), or powerful spotlights to shine upon the same area of the unit for extended periods of time. Excessive heat can deform or discolor the unit.

## IMPORTANT NOTES

- When moved from one location to another where the temperature and /or humidity is very different, water droplets (condensation) may form inside the unit, you must allow it to stand for several hours, until the condensation has completely evaporated.
- Do not allow rubber, vinyl, or similar materials to remain on the unit for long periods of time. Such objects can discolor or otherwise harmfully affect the finish.
- Do not paste stickers, decals, or the like to this instrument. Peeling such matter off the instrument may damage the exterior finish.

### Maintenance

- For everyday cleaning wipe the unit with a soft, dry cloth or one that has been slightly dampened with water. To remove stubborn dirt, use a cloth impregnated with a mild, non-abrasive detergent. Afterwards, be sure to wipe the unit thoroughly with a soft, dry cloth.
- Never use benzine, thinners, alcohol or solvents of any kind, to avoid the possibility of discoloration and/or deformation.

### Additional Precautions

- Use a reasonable amount of care when using the unit's buttons, sliders, or other controls; and when using its jacks and connectors. Rough handling can lead to malfunctions.
- When connecting/disconnecting all cables, grasp the connector itself-never pull on the cable. This way you will avoid causing shorts, or damage to the cable's internal elements.
- To avoid disturbing your neighbors, try to keep the unit's volume at reasonable levels (especially when it is late at night or near specific places like schools or hospitals).
- When you need to transport the unit, package it in the box (including padding) that it came in, if possible. Otherwise, you will need to use equivalent packaging materials.
- Some connection cables contain resistors. Do not use cables that incorporate resistors for connecting to this unit. The use of such cables can cause the sound level to be extremely low, or impossible to hear. For information on cable specifications, contact the manufacturer of the cable.

# PRODUCT ANNOUNCEMENT

## Mighty5 Products in the box

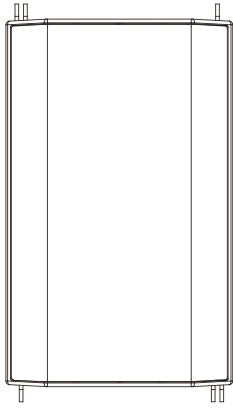

Mighty5



One out two pin×1

## Mighty5 Sub Products in the box

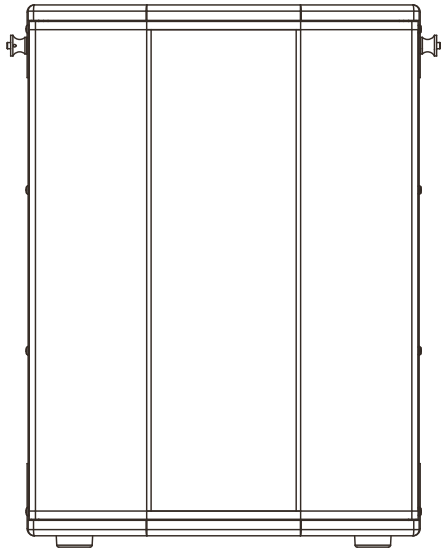

Mighty5 Sub

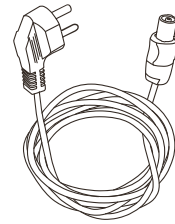

3M power cord

# ACCESSORIES

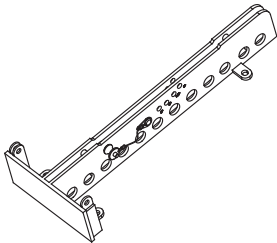

Flybar

Mighty5

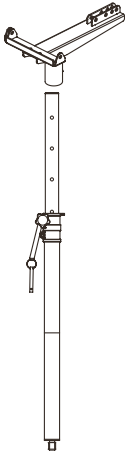

Mighty5 Adapter

Mighty5 Pole

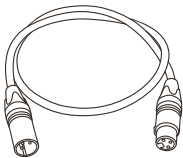

0.6M Signal Cable

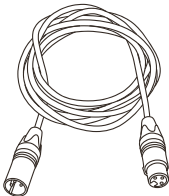

2M Signal Cable

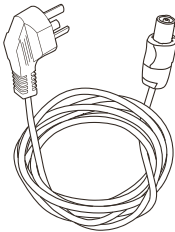

3M Power Cable

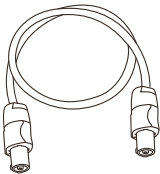

0.6M Power Cable

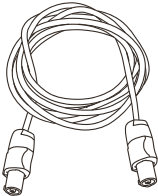

2M Power Cable



# CONFIGURATION

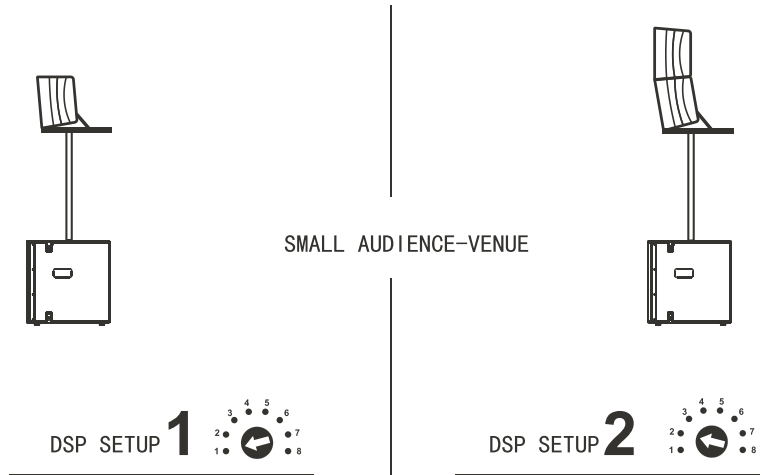

## CONFIGURATION 1

### Speaker & Accessories

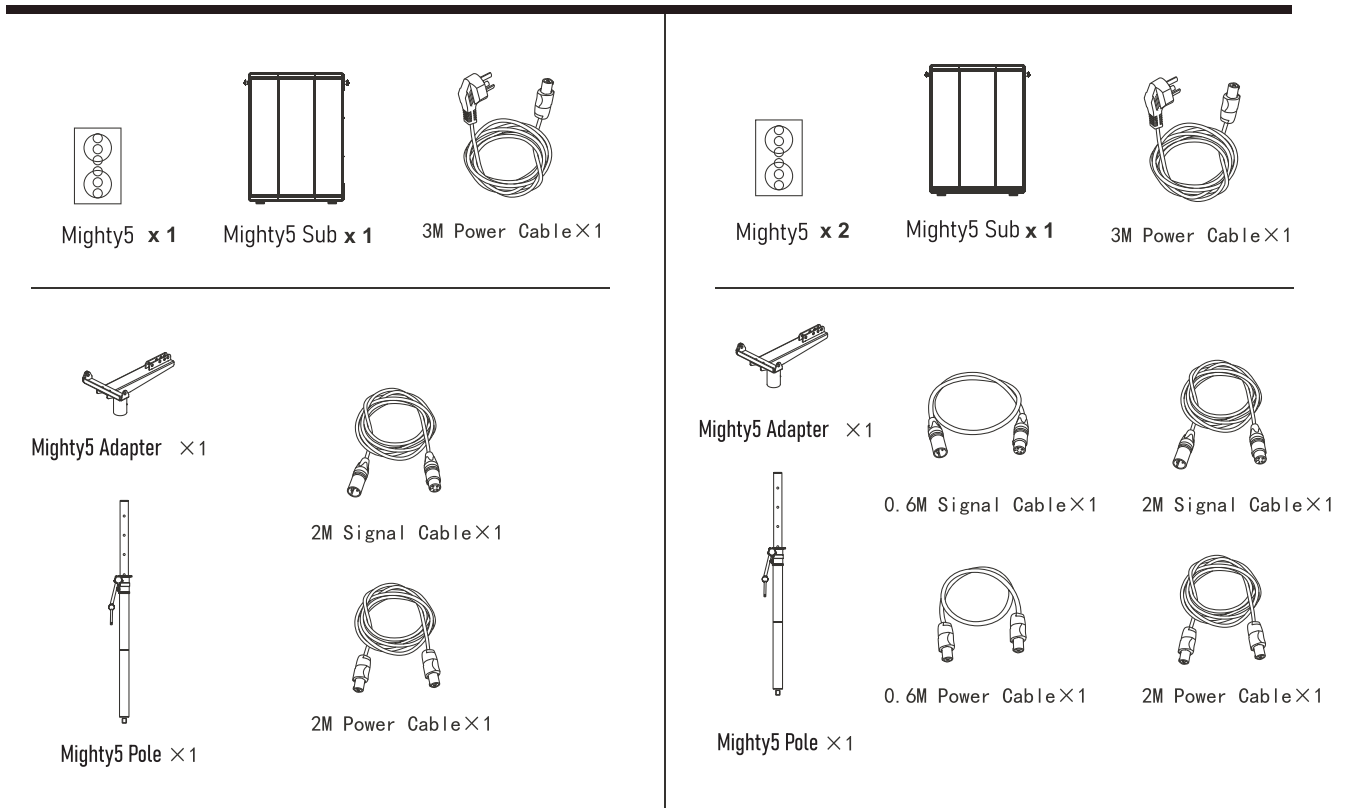

# CONFIGURATION

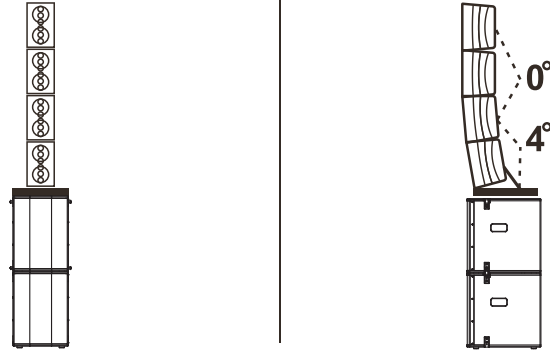

DSP SETUP **3**

## CONFIGURATION 2

Small Audience/Venue

### Speaker & Accessories



Mighty5 x 4



Mighty5 Sub x 2



3M Power Cable x 1

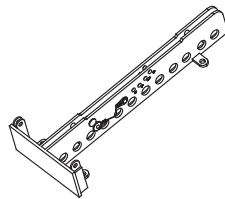

Mighty5 Sub Flybar x 1



0.6M Signal Cable x 3



2M Signal Cable x 2

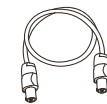



0.6M Power Cable x 3



2M Power Cable x 2

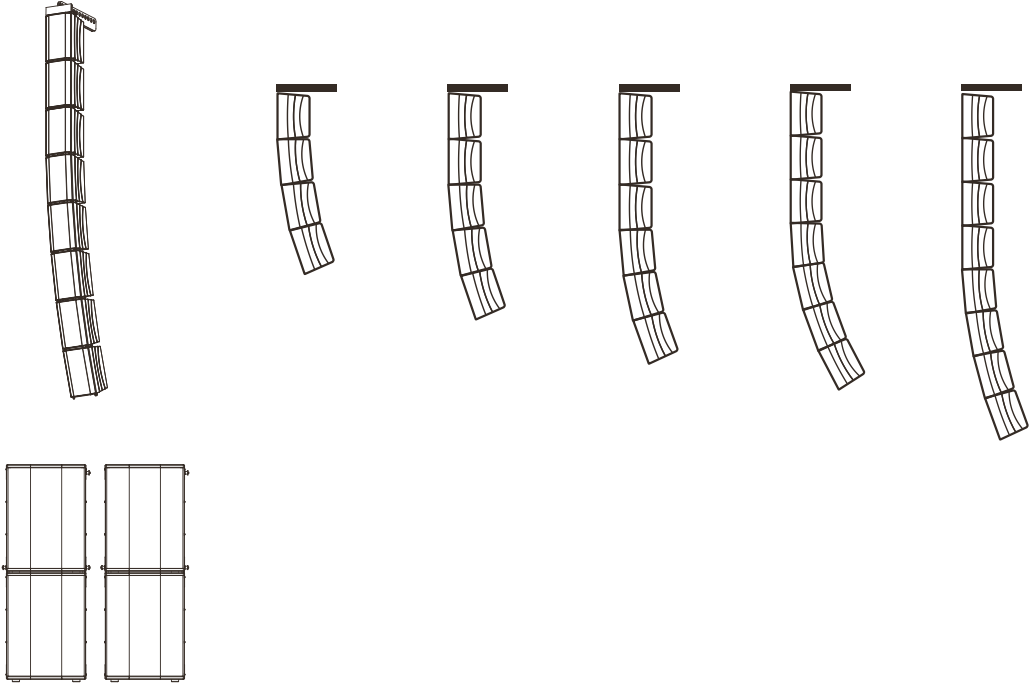





# CONF I G U R A T I O N

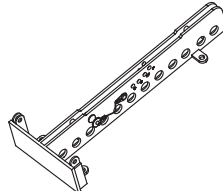

DSP SETUP **4-8**  2 x Satellite+1 x Sub  
 DSP SETUP according to the satellite quantity:4、 5、 6、 7、 8

## CONFIGURATION 3 Middle Audience/Venue

### Speaker&Accessar ies

<div style="text-align: center; margin-bottom: 20px;">                   Mighty5 x(4 - 8)             </div> <hr style="width: 50%; margin: 0 auto;"/> <div style="display: flex; justify-content: space-around;"> <div style="text-align: center;">                   Mighty5 Sub x (2 - 4)             </div> <div style="text-align: center;">                   3M Power Cable             </div> </div>	<div style="text-align: center; margin-bottom: 20px;">                   Mighty5 Flybar             </div> <div style="display: flex; justify-content: space-around;"> <div style="text-align: center;">                   0.6M Signal Cable             </div> <div style="text-align: center;">                   2M Signal Cable             </div> </div> <div style="display: flex; justify-content: space-around; margin-top: 20px;"> <div style="text-align: center;">                   0.6M Power Cable             </div> <div style="text-align: center;">                   2M Power Cable             </div> </div>
---	---

# Installation&Connection

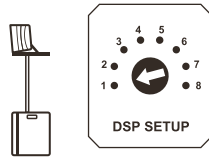
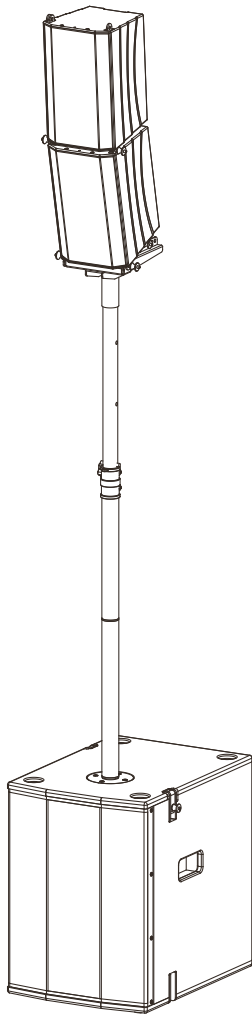

**CONFIGURATION 1:** Connect 1 pc SUB with 1pc Satellite by using of and Adaptor (Ground use and suitable for small audience/Venue)  
Switch DSP to mode 1.

- 1** 1 x Mighty5 Sub
- 2 x Mighty5

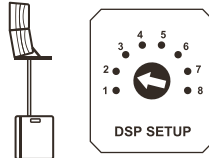

Connect 1 pc SUB with 2pcs Satellites by using of and Adaptor (Ground use and suitable for small audience/Venue)  
Switch DSP to mode 2.

- 2** 1 x Mighty5 Sub
- 2 x Mighty5

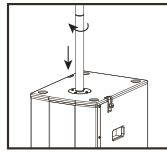

1, Screw pole-assembly into threaded pole socket of SUB.

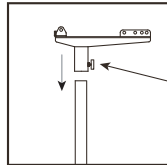

2, Connect Adapter to the pole assembly.

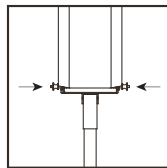

3, Use Lockpin to secure and mount assembly to ADAPTER

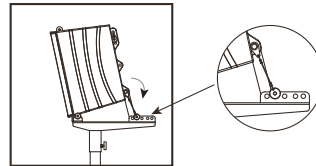

4, Flip back-bracket down and insert Lockpin into desired hole of the Adapter.

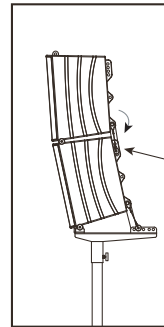

5, Stack second speaker, select desired throw angles, then connect with power cable and signal cable.

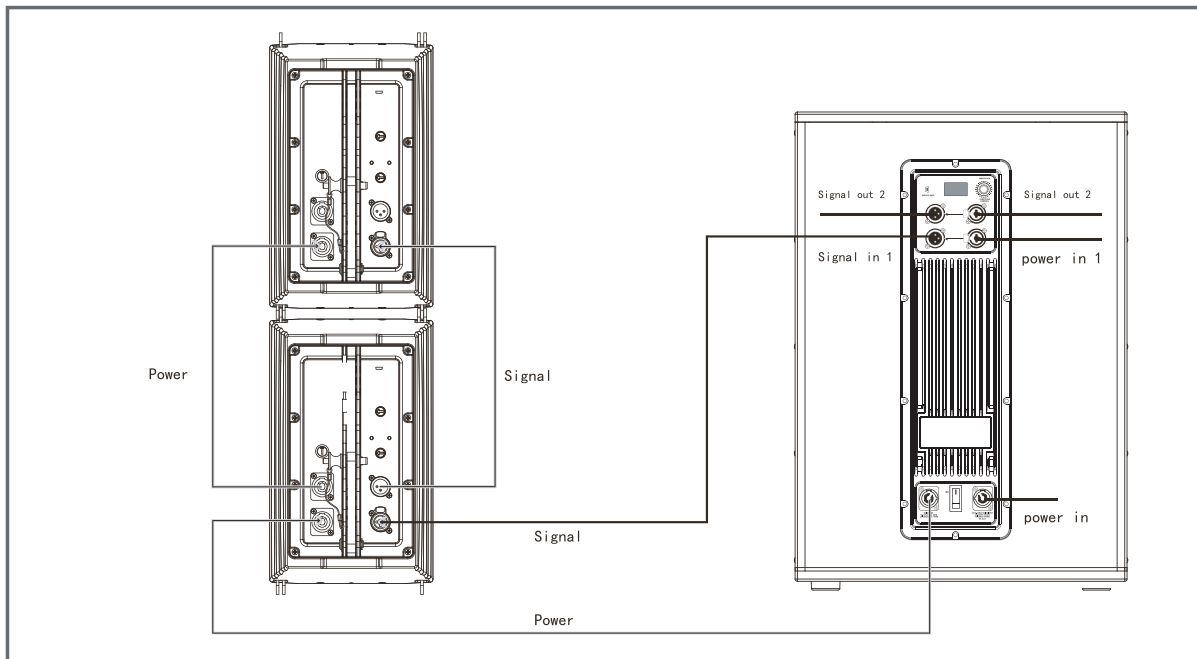

# Installation&Connection

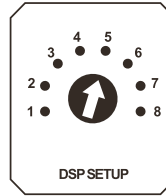

**4**

2 x Mighty5 Sub  
4 x Mighty5  
Mighty5 Sub ground use  
Switch Mighty5 DSP to mode 4.

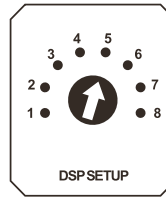

**5**

2 x Mighty5 Sub  
5 x Mighty5  
Mighty5 Sub ground use  
Switch Mighty5 DSP to mode 5.

Mighty5 can be adjust to 0/4/8/10 degree according to different hole setting.

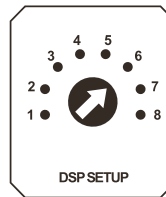
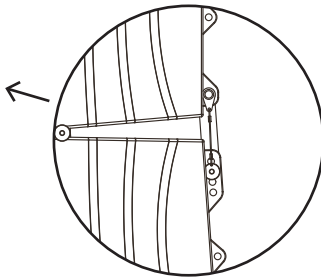

**6**

3 x Mighty5 Sub  
6 x Mighty5  
Mighty5 Sub ground use  
Switch Mighty5 DSP to mode 6.

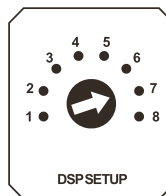
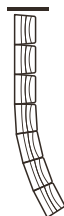

**7**

4 x Mighty5 Sub  
7 x Mighty5  
Mighty5 Sub ground use  
Switch Mighty5 DSP to mode 7.

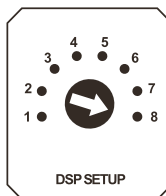

**8**

≥ 4 x Mighty5 Sub  
≥ 8 x Mighty5  
Mighty5 Sub ground use  
Switch Mighty5 DSP to mode 8.

**CONFIGURATION** : Fly using. Mode 5, 6 is suitable Audience/Venue; Mode 7, 8 is suitable for Large Audience/Venue

# Installation & Connection

1. Secure Flybar, secure top front of with lockpins, swing adjustable mounting bracket up, select throw angle, and secure with lockpin.
2. Hang each successive and secure with lockpin, select desired throw angle, then connect with power cable and signal cable.
3. With 2x stacked SUBs , secure them with lockpin.

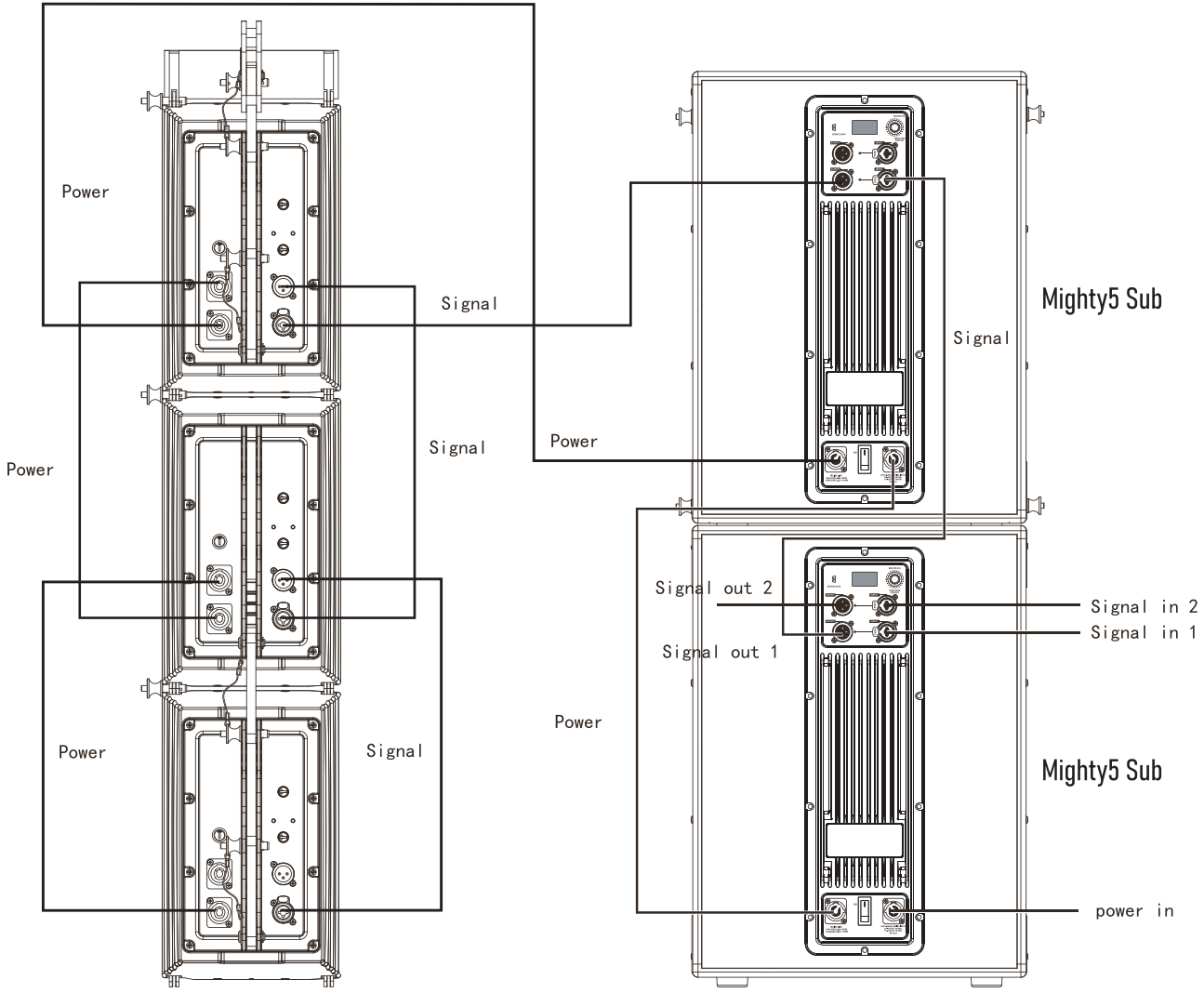

# MIGHTY5 FUNCTION INSTRUCTION

## Overview-Connections & Controls

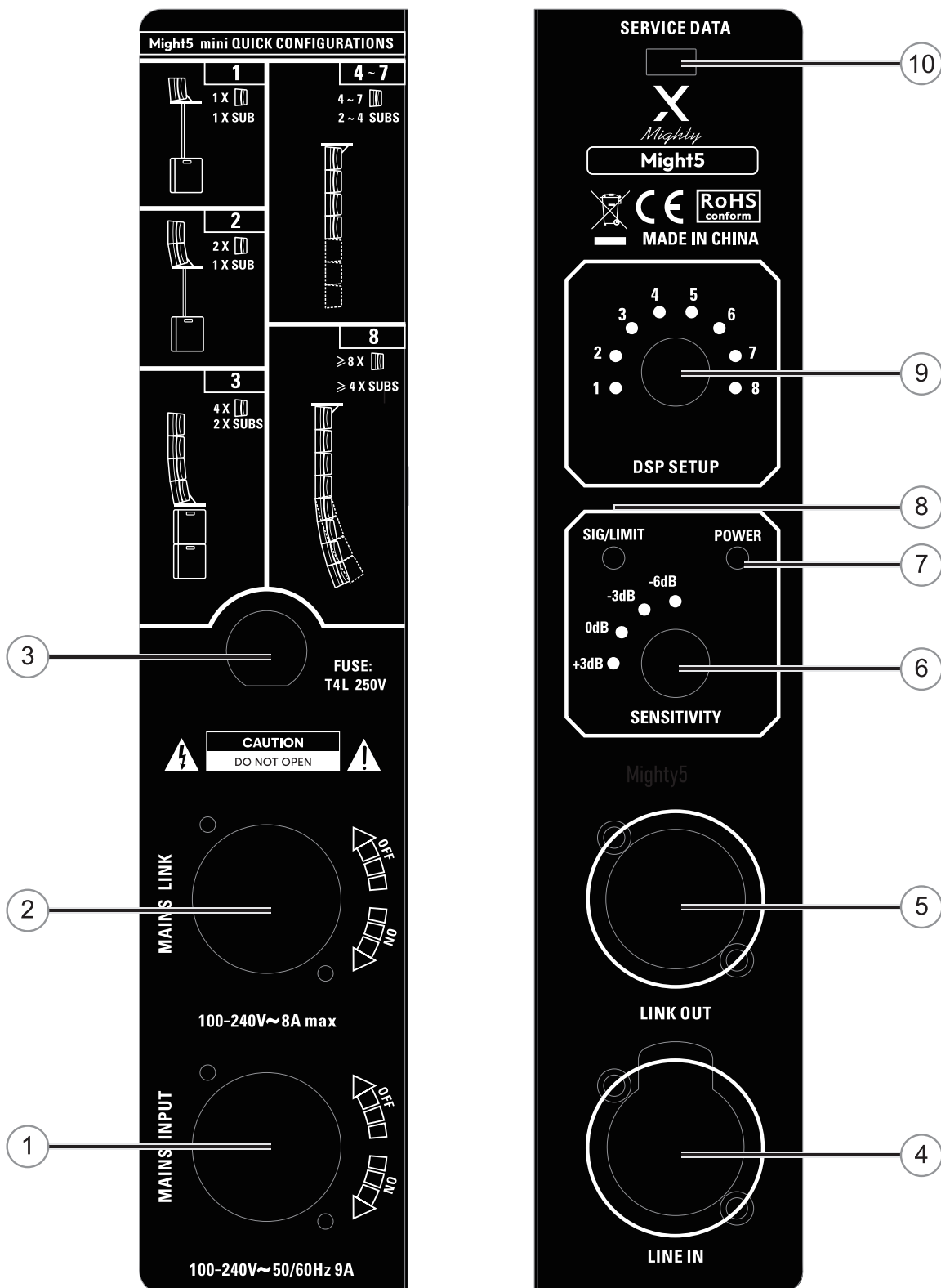

# MIGHTY5 FUNCTION INSTRUCTION

## Overview-Connections & Controlstion

### 1.MAINS INPUT:

Power input(+).

### 2.MAINS LINK:

Power output(-).Output is connected in parallel with mains input(1) and can be used to power additional speakers.

### 3.FUSE:

Slow-Blow 4.0 Amp 250V fuse(100-240V).

### 4.LINE IN:

3Pin XLR input connector(balanced line-level audio input).

### 5.LINK OUT:

3pin XLR output connector(balanced line-level audio output).

### 6.SENSITIVITY:

Control internal speaker volume(from +3dB to -6dB).

### 7.POWER:

Blue indicates main power.

### 8.SIG/LIMIT:

Green indicates a signal  $\geq 25\text{dBu}$ ,and red indicated that the internal limiter that the internal circuit has tripped,preventing amplifier distortion and speaker overloads.

### 9.DSP SETUP:

8-position rotary switch selects between 8 equalization curve and DSP presets.

### 10.SERVICE DATA:

Only used by IHOS customer service department.Please do not insert any other USB.



# MIGHTY5 SUB FUNCTION INSTRUCTION

## Function Instruction



# MIGHTY5 SUB FUNCTION INSTRUCTION

## Overview-Connections & Controlstion

### 1.MAINS LINK:

Power output(-).

### 2.MAINS INPUT:

Power input(+).

### 3.POWERSWITCH:

Power on/Power off.

### 4.SERVICE DATA:

Only used by IHOS customer service department.Please do not insert any other USB device.

### 5.OUTPUT1:

Can be connected to the signal input interface oaf another MILOS PRO and the output signal is the same as the Input1 signal.

### 6.OUTPUT2:

Can be connected to the signal input interface of another MILOS PRO and the output signal is the same as the Input2 signal.

### 7.LCD:

Display working status and DSP control interface.

### 8.FUNCTIONS CONTROL:

Rotate clockwise/counterclockwise for selection/adjustment, press the knob to enter/confirm.

### 9.INPUT1:

Can be connected with LINE signal.

### 10.INPUT2:

Can be connected with LINE signal.

## SPECIFICATION

Item	Mighty5 Sub	Mighty5
Type	Active Bandpass Subwoofer	2 Way Active Vented Design
Frequen Response	40~120Hz	100~20KHz
Impedance	8Ω	8Ω
Crossover Point	100/120Hz (Selectable)	1.1KHz
Expansion	/	90° (H) *20° (V)
Max SPL (1M)	130dB	128dB
Amplifer Power (RMS)	700 W	220W (LF)+220 W (HF) TOTAL 440W
SPL Input	-6dBV	-6dBV
Signal Input Interface	1*XLR	1*XLR
Signal Input Interface	1*XLR	1*XLR
Power Input Interface	POWERCON IN	POWERCON IN
Power Output Interface	POWERCON OUT	POWERCON OUT
Power Input	220 - 240 VAC ~ 50 / 60Hz	100 - 240 VAC ~ 50 / 60Hz
Fuse	T4AL 250V	T4AL 250V
limiter	DSPLimiter	DSPLimiter
Driver	12"	Woofer:2*4.75";Tweeter: 6*1.75"
Cabinet	Plywood	ABS
Grill	1.2mm Steel	1.0mm Steel
Pallet	M20 Aluminium Pallet	/
Fly Using	Rope+Flybar	Rope+Flybar
Color	Black	Black
Model Size	520*380*530mm	333*185*225mm
Model Weight (Net weight)	27.8kg	5.7kg
Package size	65*51*65.5cm/1pc	57.5*29*26.5cm/1pcs
Gross Weight	32kg	6.7kg

**NOTE:** Products are subject to a precess of continuous development. Thus, the product specification in this user manual may be inconsi

# SUPPORT AND TROUBLESHOOTING

TROUBLESHOOTING	
<b>No sound from the loudspeaker</b>	A. Make sure the power cord is fully and securely inserted in the IEC receptacle and in the outlet.
	B. Make sure all cables and other connected devices are properly and securely connected.
	C. Make sure the volume shouldn't be set to minimum.
<b>Noise</b>	A. Make sure the devices are normal.
	B. Make sure speaker cable connect normally.
<b>No sound from satellite</b>	A. Make sure Satellite connected with Subwoofer or Satellite normally.
	B. Make sure all cables and other connected devices are properly and securely connected.
<b>satellite sound problem</b>	A. Make sure DSP set to a correct combination mode, total: three combination modes.
<b>Subwoofer volume low</b>	A. Make sure BASS GAIN knob set to 12 o'clock.
<b>Screaming, noise, distorted sound from the Microphone</b>	A. Check to adjust the microphone volume and reverb to a appropriate level.
	B. Adjust the distance between the microphone and loudspeaker. Must not point to the microphone to loudspeaker directly.
	C. Make sure set tweeter EQ to a suitable range.
<b>Sound breaks up intermittently or sound distorts</b>	A. Make sure signal input don't over the range
	B. Make sure signal gain don't over the range.

with what you received.







**MYFIX**

---

고객센터 : 031.709.1061

주 소 : 경기 성남시 분당구 판교로 723 분당테크노파크 B동 604-2호 세븐스튜디오